

A-3Core E User Guide

POWER AMPLIFIER

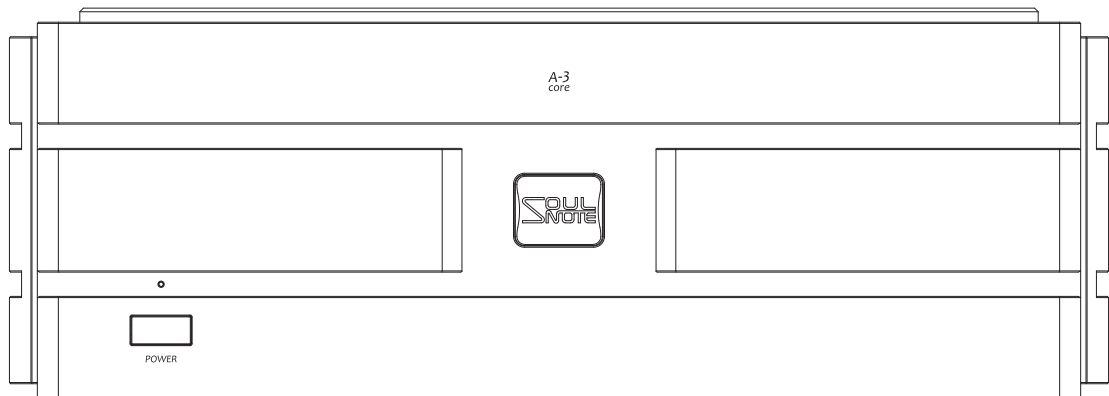

Table of Contents

Safety Precautions.....	3
Front Panel Names and Functions	6
Rear Panel Names and Functions.....	7,8
Features of This Product	9
Balanced Input/Output.....	11
Attaching the Spike Pins.....	11
Protection Pads for Transport.....	12
About Installation	12
Troubleshooting	13
Maintenance	13
Specifications.....	13

Supplied Accessories

• User Guide (this manual)	1	• Spike pin	3
• Power cable	1	• Hex key for spike pins	1
• Spike-receiving board	1		
• Setting spacer	3		

Safety Precautions



CAUTION

RISK OF ELECTRIC SHOCK
DO NOT OPEN



CAUTION: TO REDUCE THE RISK OF ELECTRIC SHOCK, DO NOT REMOVE COVER (OR BACK). NO USER-SERVICEABLE PARTS INSIDE. REFER SERVICING TO QUALIFIED SERVICE PERSONNEL.



The lightning flash with arrowhead symbol, within an equilateral triangle, is intended to alert the user to the presence of uninsulated “dangerous voltage” within the product’s enclosure that may be of sufficient magnitude to constitute a risk of electric shock to persons.



The exclamation point within an equilateral triangle is intended to alert the user to the presence of important operating and maintenance (servicing) instructions in the literature accompanying the product.

WARNING

TO REDUCE THE RISK OF FIRE OR ELECTRIC SHOCK, DO NOT EXPOSE THIS APPLIANCE TO RAIN OR MOISTURE.

A warning that an apparatus with CLASS I construction shall be connected to a MAINS socket outlet with a protective earthing connection.

IMPORTANT SAFETY INSTRUCTIONS

READ BEFORE OPERATING EQUIPMENT

This product was designed and manufactured to meet strict quality and safety standards. There are, however, some installation and operation precautions which you should be particularly aware of.

1. Read these instructions.
2. Keep these instructions.
3. Heed all warnings.
4. Follow all instructions.
5. Do not use this apparatus near water.
6. Clean only with dry cloth.
7. Do not block any ventilation openings.
Install in accordance with the manufacturer's instructions.
8. Do not install near any heat sources such as radiators, heat registers, stoves, or other apparatus (including amplifiers) that produce heat.
9. Protect the power cord from being walked on or pinched particularly at plugs, convenience receptacles, and the point where they exit from the apparatus.
10. Only use attachments/accessories specified by the manufacturer.
11. Use only with the cart, stand, tripod, bracket, or table specified by the manufacturer, or sold with the apparatus. When a cart is used, use caution when moving the cart/apparatus combination to avoid injury from tip-over.
12. Unplug this apparatus during lightning storms or when unused for long periods of time.
13. Refer all servicing to qualified service personnel. Servicing is required when the apparatus has been damaged in any way, such as power-supply cord or plug is damaged, liquid has been spilled or objects have fallen into the apparatus, the apparatus has been exposed to rain or moisture, does not operate normally, or has been dropped.
14. Batteries shall not be exposed to excessive heat such as sunshine, fire or the like.



CAUTION:

- To completely disconnect this product from the mains, disconnect the plug from the wall socket outlet. The mains plug is used to completely interrupt the power supply to the unit and must be within easy access by the user.
- Never use the unit with any other cord except the supplied power cord.

NOTE ON USE

WARNINGS

- Avoid high temperatures.
Allow for sufficient heat dispersion when installed in a rack.
- Handle the power cord carefully.
Hold the plug when unplugging the cord.
- Keep the unit free from moisture, water, and dust.
- Unplug the power cord when not using the unit for long periods of time.
- Do not obstruct the ventilation holes.
- Do not let foreign objects into the unit.
- Do not let insecticides, benzene, and thinner come in contact with the unit.
- Never disassemble or modify the unit in any way.
- Ventilation should not be impeded by covering the ventilation openings with items, such as newspapers, tablecloths or curtains.
- Naked flame sources such as lighted candles should not be placed on the unit.
- Observe and follow local regulations regarding battery disposal.
- Do not expose the unit to dripping or splashing fluids.
- Do not place objects filled with liquids, such as vases, on the unit.
- Do not handle the mains cord with wet hands.
- When the switch is in the OFF position, the equipment is not completely switched off from MAINS.
- The equipment shall be installed near the power supply so that the power supply is easily accessible.

DECLARATION OF CONFORMITY

We declare under our sole responsibility that this product, to which this declaration relates, is in conformity with the following standards:

EN60065, EN55032, EN55020.

Following the provisions of Low Voltage Directive 2014/35/EU and EMC Directive 2014/30/EU.

A NOTE ABOUT RECYCLING:

This product's packaging materials are recyclable and can be reused. Please dispose of any materials in accordance with the local recycling regulations. When discarding the unit, comply with local rules or regulations.

Batteries should never be thrown away or incinerated but disposed of in accordance with the local regulations concerning battery disposal. This product and the supplied accessories, excluding the batteries, constitute the applicable product according to the WEEE directive.



Pb

CAUTIONS ON INSTALLATION

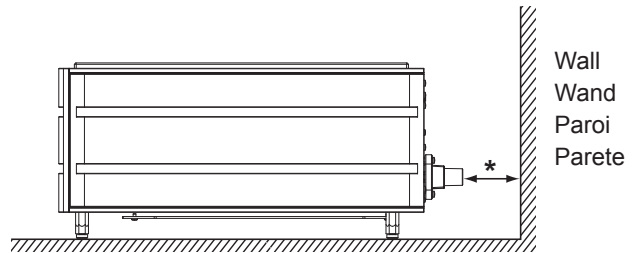
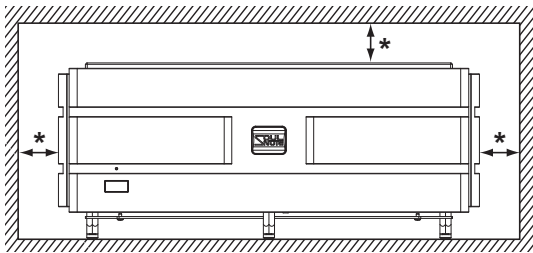

*** For proper heat dispersal, do not install this unit in a confined space, such as a bookcase or similar enclosure.**

- Leave sufficient clearance (at least 10 cm) from the wall, (at least 5 cm) from top surface of the unit.
- Do not place any other equipment on this unit.

Front Panel Names and Functions

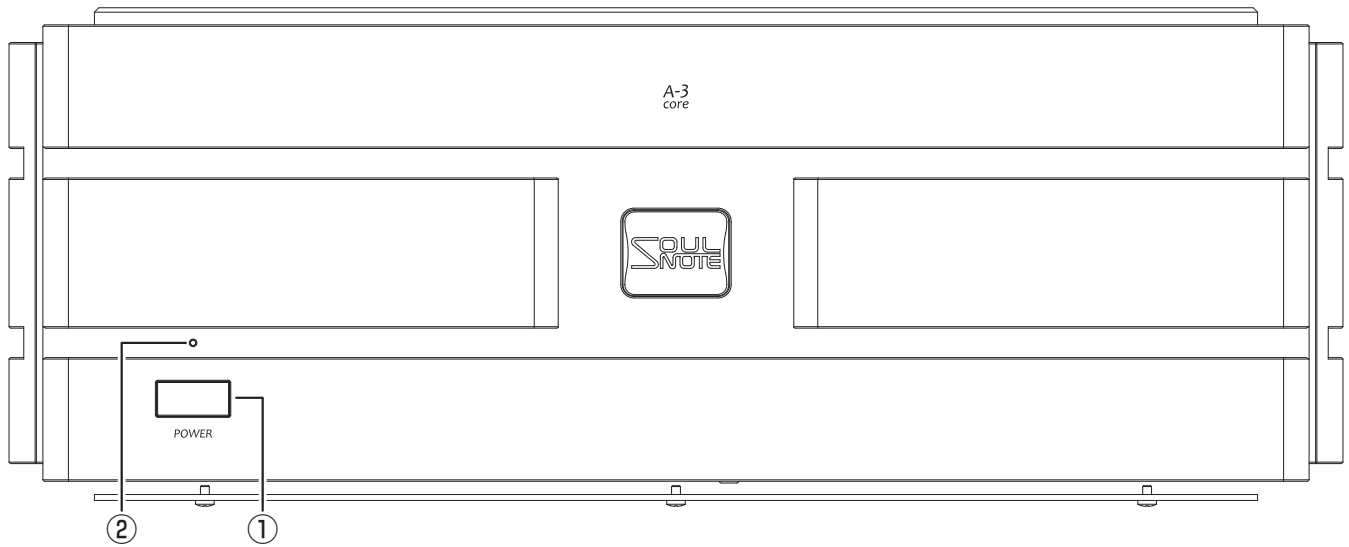

① Power Switch (POWER)

Press to turn on the power, and press again to turn off.

② Power Indicator (POWER)

Once the power is on, the indicator turns yellow. Once the mute is canceled, the indicator turns blue.

Note:

- When the GND switch on the rear panel is in the CONNECTION mode, the indicator is lit red.

Rear Panel Names and Functions

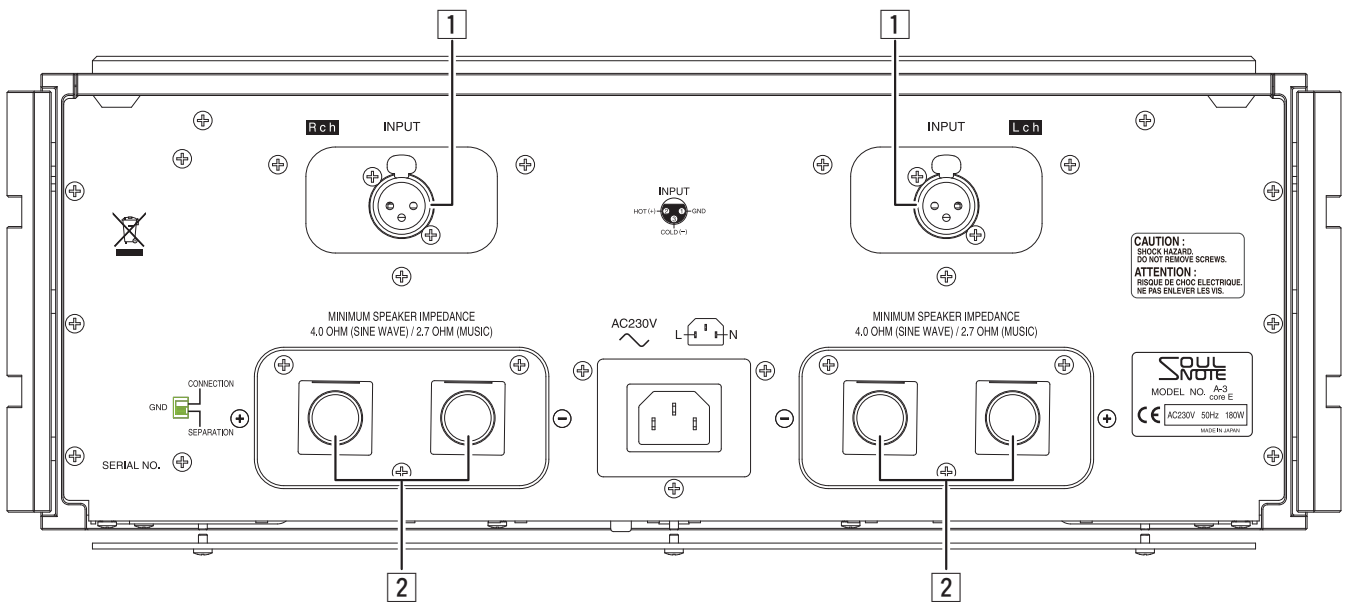

1 Audio Input Terminals (INPUT)

These terminals are used to input balanced audio signals via an XLR connector cable. Pin 2 is HOT and pin 3 is COLD.

2 Speaker Terminals

These terminals are used for speaker connections. To each of these speaker terminals, 2.7-ohm or higher speakers can be connected.

Notes:

- Turn off the power before connecting a cable to the input terminal or the speaker terminal, or before reconnecting speakers that are connected via speaker cables.
- Due to the superior frequency characteristic of the main unit, DO NOT connect any devices other than speakers. Connecting a speaker selector or measuring equipment causes a high-frequency connection of the input GND and the output GND, which may result in protection circuit activation or malfunction of the main unit.
- Whenever possible, keep the speaker cables and input cable apart from each other.
- While each of output terminals consist of the ⊕ (red) and ⊖ (black) polarities, speaker systems also have the ⊕ and ⊖ polarities. Be sure to connect ⊕ to ⊕ and ⊖ to ⊖ (except for BTL connections).

- About speaker cables

When using RSC-04/06/10 (sold separately), connect the cables as shown below.

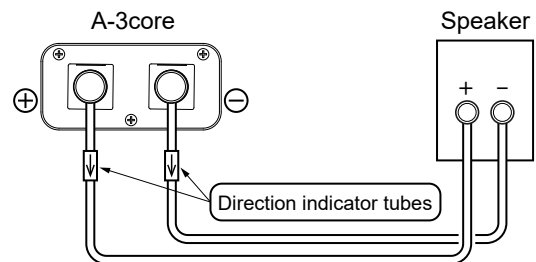

Notes:

- When disconnecting cables, be careful not to drop the direction indicator tubes.
- Use a wire stripper or utility knife to peel about 2 cm off the insulation coating.

Rear Panel Names and Functions

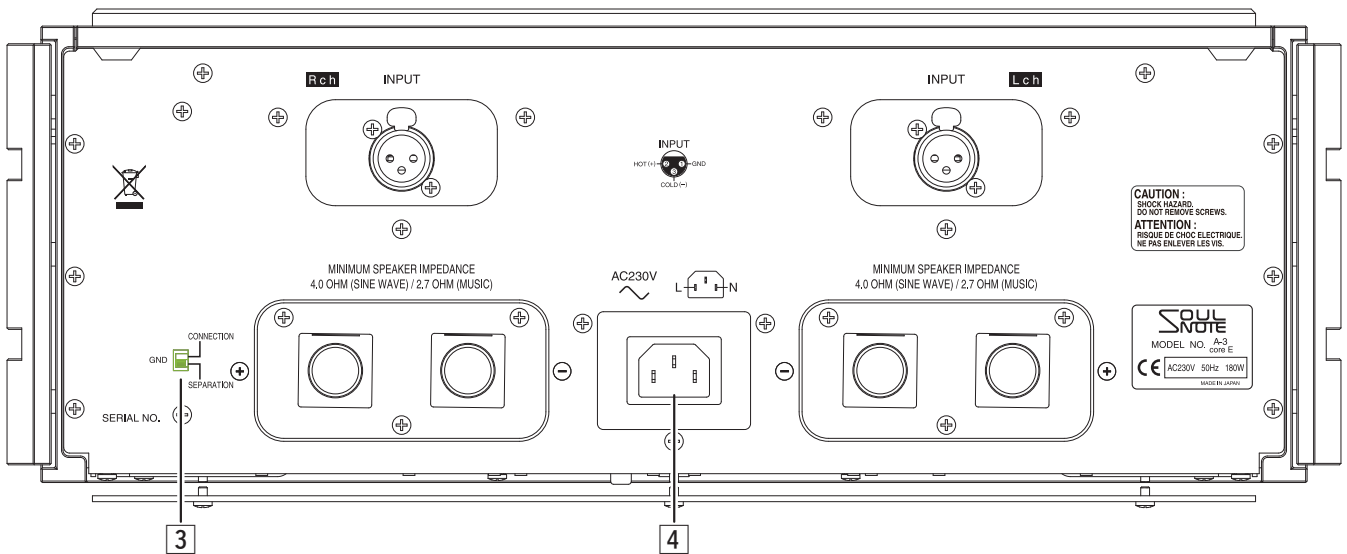

3 GND Switch (SEPARATION/CONNECTION)

This switch connects separated right and left analog GND to the main chassis.

SEPARATION:

Separates the right and left analog GNDs from the main chassis. To obtain better audio quality, keep the switch in this position.

- The Power Indicator is lit blue.

CONNECTION:

Connects analog GND to the main chassis. When noise or the like occurs, set the switch to this position.

- The Power Indicator is lit red.

4 AC Inlet (AC230V)

Connect to a 230 V AC wall outlet (mains) with the supplied power cable.

Notes:

- To maintain the audio quality, use the supplied power cable.
- Firmly insert the power cable into the end of the AC inlet.

Cautions

- **Do not use any electrical contact cleaner or the like in the AC inlet area.**

Features of This Product

Feature 1: Complete Separation of the Right and Left GND Channels

We have applied the complete GND separation technology incorporated in the P-3 preamplifier to A-3core that has a power amplifier circuit. Originally, how to ground the GND of a power amplifier that handles high current to the chassis was a key design issue, and there was no precedent for ungrounded GND. However, the ungrounding of the power amplifier's enclosure was achieved through the simple non-NFB circuit, optimized artwork design, minimization of high current loops, elimination of inductance components, and other factors. This led to the birth of the stereo power amplifier A-3core featuring completely separated left and right GNDs. Furthermore, by separating the control signals of the protection circuit, and other relays with a photocoupler, we achieved complete GND separation that takes capacitance and inductive components into consideration. The three-dimensional sound field space and spaciousness are the new frontiers of stereo power amplifiers.

Feature 2: Single Push-pull Output Stage

For the output stage, we have adopted the single push-pull SEPP circuit using the TO-3 (metal can type) bipolar transistor that is used in M-3. It can play blur-free music at the correct timing, supporting from ultra-low to ultra-high frequencies. The heart-stirring music playback is achieved by single push-pull which does not spoil micro-time axis accuracy.

Feature 3: Four-stage Darlington Configuration with Super-powerful Driver and Pre-driver

To drive the TO-3 (metal can type) transistor easily, ultra-powerful TO-3P transistors are used in the driver as well as in the pre-driver. Ensuring perfect current supply all the way to the bottom end without regard to hfe fluctuation at high currents makes it possible to achieve deeply expressive and groovy sounds.

Feature 4: New Type-R Circuit Adopted

For voltage amplification, we have newly developed the high-gain-to-GND single-stage Type-R amplification circuit. Naked foil resistors are used generously for all resistors that are involved in amplifier operation.

Feature 5: GND Anchor

The GND in the left and right channel is grounded to the left/right-side metal that is insulated by ceramic washers. We have adopted a special enclosure structure that serves as a GND anchor. A sense of openness and low-end grip are achieved at a high level.

Feature 6: Super-strong Power Transformer

Two 700VA unimpregnated toroidal power transformers are used on the left and right for the power amplification. In addition, three power transformers, including the control system power transformer, are packed into one enclosure. They are all mounted vertically so that the magnetic field lines are parallel to the board.

Feature 7: High-speed non-NFB Power Supply

For the rectifying capacitor, we have adopted a specially-selected low magnification foil filter capacitor of only 470uF featuring high-withstand voltage and low capacitance. We have adjusted the number of the capacitors to be used in order to optimize the capacitance, thereby reducing the load on the power transformer. This further improves real regulation of the ultra-powerful power transformer. For the rectifier diodes, we have adopted SiC diodes of the latest specifications with enhanced allowable inrush current. This is the most powerful and high-speed power supply configuration conceivable. In addition, two unsecured large power relays with excellent sound quality are used independently as power switches for the two main power transformers. In other words, the Power Switch on the front panel is dedicated to the control system sub-transformer. Having an independent power switch for each power transformer, which is a high current contact point, is extremely crucial for sound quality.

Feature 8: Heat Sink That Also Serves as Copper Bus Bar

Lightweight, small copper plates are used for the main heat sink. This heat sink also serves as a bus bar that supplies power to the TO-3 (metal can type) transistor, and the terminals of the TO-3 (metal can type) transistor penetrate the bus bar and are connected directly to the board underneath. Thus, we eliminated wiring which is a drawback of the TO-3 (metal can type) transistor to overcome instability caused by the inductance component while eliminating sound quality degradation that is caused by insulation sheet damping on the device. The physical independence of the heat sink from the chassis also has a profound effect on the sound quality, creating a sense of freedom and transparency. Furthermore, in A-3core, the power supply board and amplifier board are connected by a bus bar heat sink which also serves as a structural component to form a block. It is truly a “four birds with one stone” heat sink.

Feature 9: Unsecured Structure

The amplifier block, terminals, AC inlet, top cover, and bottom cover are all unsecured. We especially focused on the amplifier block by adopting the three-point lateral sliding structure using titanium sliders. While escaping from the harmful vibration of the power transformer, it also releases its own intrinsic vibration.

- For more detailed information, refer to our website or Facebook page.
https://www.kcsr.co.jp/eu_soulnote.html

Balanced Input/Output

The XLR Connector is used for Balanced Input/Output. There are two types of connection, “European Type” and “USA Type”.

1. European Type (adapter for this unit)

(pin 2 = HOT, pin 3 = COLD)

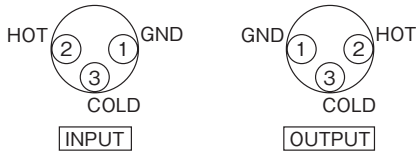

2. USA Type

(pin 2 = COLD, pin 3 = HOT)

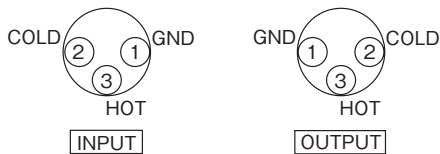

Attaching the Spike Pins

By replacing the feet with the supplied spike pins, you can tune the audio quality. Point grounding makes the sound focus and auditory lateralization sharper. Furthermore, the audio quality can be subtly tuned by changing the material of the surface on which this equipment is installed.

Notes:

- When replacing the feet with the spike pins, remove the carbon washers from the feet, and then reattach them to the spike pins.
- When the spike pins are attached, it may be difficult to keep weight balance stable. Take great care not to carelessly apply a force on the corners of the main unit.

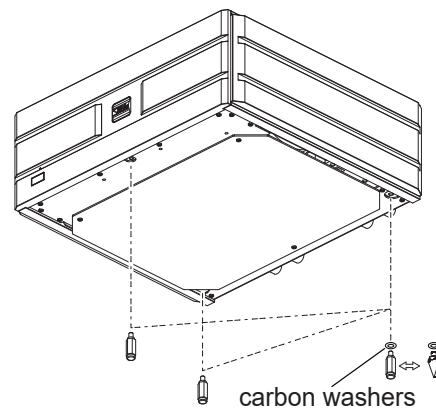

Cautions

- When using the spike pins, be extremely careful not to get injured, etc.
- When using the spike pins, be careful that the surface on which the main unit is installed such as the surface of a table, shelf, etc., may become damaged. Using the spike-receiving board is highly recommended in order to protect the installation surface.

Protection Pads for Transport

When unboxing this product, be sure to remove the transport cushions. With the cushions left attached, the intended sound quality of this product cannot be fully enjoyed.

- In order to obtain better sound quality, the top cover, the bottom cover, and the terminals on the rear panel are not secured.
- If you shake the unit, you will hear a rattling sound. It is not an abnormality.
- When you transport the unit, reattach the pads to the original places.

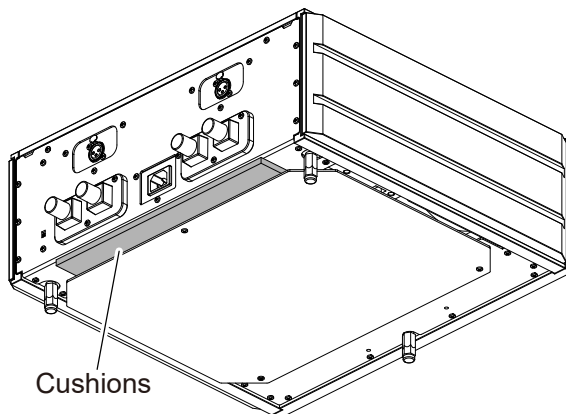
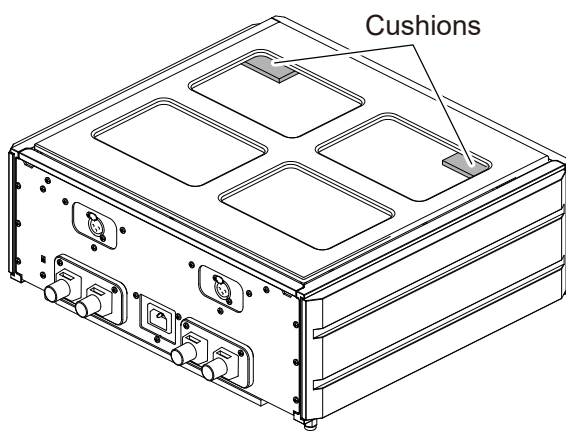

About Installation

When this product is installed on your shelf or audio rack with the spike pins attached, the supplied spike-receiving board can protect the installation surface from scratching.

Using the setting spacers along with the spike-receiving board ensures that there is space between the installation surface and the spike-receiving board. With that space, the air hole of the spike-receiving board can be utilized. This can further improve the sound quality.

The setting spacers can also be used alone as spike receivers.

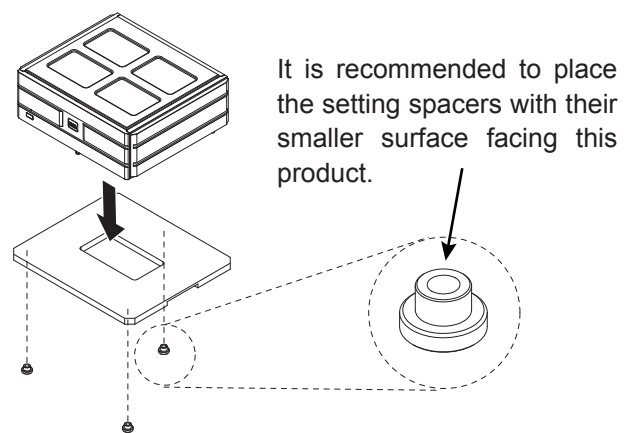

Troubleshooting

No sound is output.

- Check that the power of the main unit is on.
- Check the connections of the external devices.
- Check that the power of the external devices is on.
- Check that the operations and settings on the external devices are correct.
- Check the connections of the speaker system.

Maintenance

When the unit has become dirty, wipe it clean using a soft cloth. To remove stubborn stains, dilute some neutral dish-washing liquid in 5 or 6 times as much water, soak a soft cloth in the solution, wring it out well, wipe away the stains, and then wipe the surfaces dry with a dry cloth.

Never use alcohol, paint thinners, benzine, insecticides or other volatile substances since they may mar or remove the surface gloss.

Bear in mind that rubbing surfaces with a chemical cleaning cloth or leaving such a cloth in contact with a surface for an extended time may result in deterioration.

Specifications

Maximum output.....	120 W x 2 (4 ohm)
Total harmonic distortion	0.27% (8 ohm, 1 W)
Frequency characteristic	
.....	2 Hz to 200 kHz (± 3.0 dB 8 ohm, 1 W)
Input sensitivity / Impedance	480 mV / 24 kohm
Gain	33 dB
S/N ratio	110 dB
Power voltage.....	230 V AC , 50 Hz
Power consumption	
.....	180 W/86 W (When no signal)
Maximum external dimensions	
	454 (W) x 189 (H) x 435 (D) mm
Weight	29 kg



SOULNOTE, Inc.

<https://www.soulnote.link/>