

A-2E User Guide

INTEGRATED AMPLIFIER

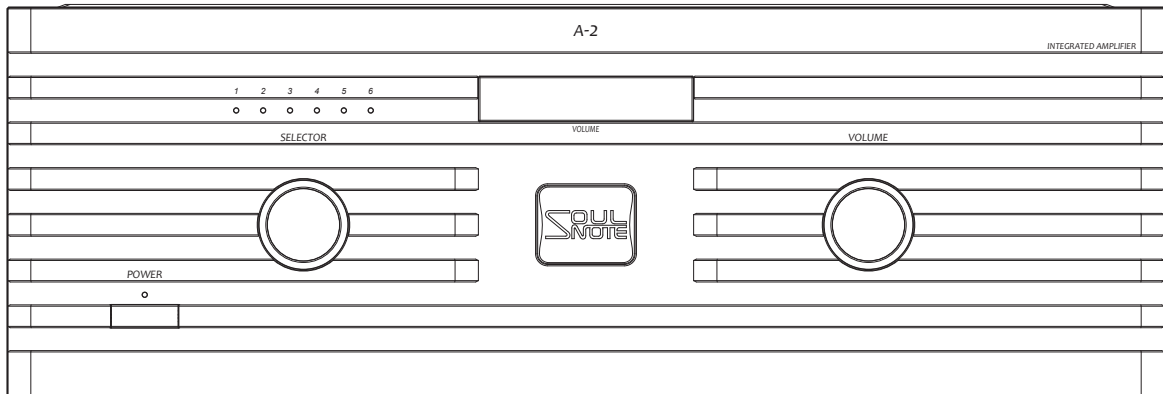

Table of Contents

Safety Precautions.....	3
Front Panel Names and Functions	6
Rear Panel Names and Functions.....	7
Remote Control Button Names and Functions	9
Display	9
Remote Control.....	10
Balanced Input/Output	10
Attaching the Spike Pins.....	11
Troubleshooting	11
Maintenance	11
Specifications.....	11

Supplied Accessories

• User Guide (this manual)	1	• Remote control	1
• Power cable	1	• AAA (LR03/R03) battery	2
• Spike pin	3		

Safety Precautions

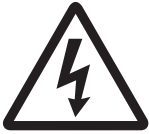

CAUTION

RISK OF ELECTRIC SHOCK
DO NOT OPEN



CAUTION: TO REDUCE THE RISK OF ELECTRIC SHOCK, DO NOT REMOVE COVER (OR BACK). NO USER-SERVICEABLE PARTS INSIDE. REFER SERVICING TO QUALIFIED SERVICE PERSONNEL.



The lightning flash with arrowhead symbol, within an equilateral triangle, is intended to alert the user to the presence of uninsulated “dangerous voltage” within the product’s enclosure that may be of sufficient magnitude to constitute a risk of electric shock to persons.



The exclamation point within an equilateral triangle is intended to alert the user to the presence of important operating and maintenance (servicing) instructions in the literature accompanying the product.

WARNING

TO REDUCE THE RISK OF FIRE OR ELECTRIC SHOCK, DO NOT EXPOSE THIS APPLIANCE TO RAIN OR MOISTURE.

A warning that an apparatus with CLASS I construction shall be connected to a MAINS socket outlet with a protective earthing connection.

IMPORTANT SAFETY INSTRUCTIONS
READ BEFORE OPERATING EQUIPMENT

This product was designed and manufactured to meet strict quality and safety standards. There are, however, some installation and operation precautions which you should be particularly aware of.

1. Read these instructions.
2. Keep these instructions.
3. Heed all warnings.
4. Follow all instructions.
5. Do not use this apparatus near water.
6. Clean only with dry cloth.
7. Do not block any ventilation openings.
Install in accordance with the manufacturer's instructions.
8. Do not install near any heat sources such as radiators, heat registers, stoves, or other apparatus (including amplifiers) that produce heat.
9. Protect the power cord from being walked on or pinched particularly at plugs, convenience receptacles, and the point where they exit from the apparatus.
10. Only use attachments/accessories specified by the manufacturer.
11. Use only with the cart, stand, tripod, bracket, or table specified by the manufacturer, or sold with the apparatus. When a cart is used, use caution when moving the cart/apparatus combination to avoid injury from tip-over.
12. Unplug this apparatus during lightning storms or when unused for long periods of time.
13. Refer all servicing to qualified service personnel. Servicing is required when the apparatus has been damaged in any way, such as power-supply cord or plug is damaged, liquid has been spilled or objects have fallen into the apparatus, the apparatus has been exposed to rain or moisture, does not operate normally, or has been dropped.
14. Batteries shall not be exposed to excessive heat such as sunshine, fire or the like.



CAUTION:

- To completely disconnect this product from the mains, disconnect the plug from the wall socket outlet. The mains plug is used to completely interrupt the power supply to the unit and must be within easy access by the user.
- Never use the unit with any other cord except the supplied power cord.

NOTE ON USE

WARNINGS

- Avoid high temperatures.
Allow for sufficient heat dispersion when installed in a rack.
- Handle the power cord carefully.
Hold the plug when unplugging the cord.
- Keep the unit free from moisture, water, and dust.
- Unplug the power cord when not using the unit for long periods of time.
- Do not obstruct the ventilation holes.
- Do not let foreign objects into the unit.
- Do not let insecticides, benzene, and thinner come in contact with the unit.
- Never disassemble or modify the unit in any way.
- Ventilation should not be impeded by covering the ventilation openings with items, such as newspapers, tablecloths or curtains.
- Naked flame sources such as lighted candles should not be placed on the unit.
- Observe and follow local regulations regarding battery disposal.
- Do not expose the unit to dripping or splashing fluids.
- Do not place objects filled with liquids, such as vases, on the unit.
- Do not handle the mains cord with wet hands.
- When the switch is in the OFF position, the equipment is not completely switched off from MAINS.
- The equipment shall be installed near the power supply so that the power supply is easily accessible.

DECLARATION OF CONFORMITY

We declare under our sole responsibility that this product, to which this declaration relates, is in conformity with the following standards:

EN60065, EN55032, EN55020.

Following the provisions of Low Voltage Directive 2014/35/EU and EMC Directive 2014/30/EU.

A NOTE ABOUT RECYCLING:

This product's packaging materials are recyclable and can be reused. Please dispose of any materials in accordance with the local recycling regulations. When discarding the unit, comply with local rules or regulations.

Batteries should never be thrown away or incinerated but disposed of in accordance with the local regulations concerning battery disposal. This product and the supplied accessories, excluding the batteries, constitute the applicable product according to the WEEE directive.



Pb

CAUTIONS ON INSTALLATION

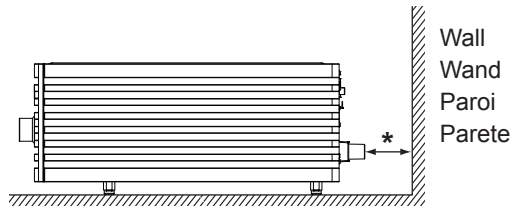
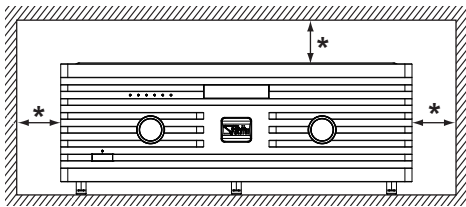

*** For proper heat dispersal, do not install this unit in a confined space, such as a bookcase or similar enclosure.**

- Leave sufficient clearance (at least 10 cm) from the wall, (at least 5 cm) from top surface of the unit.
- Do not place any other equipment on this unit.

Front Panel Names and Functions

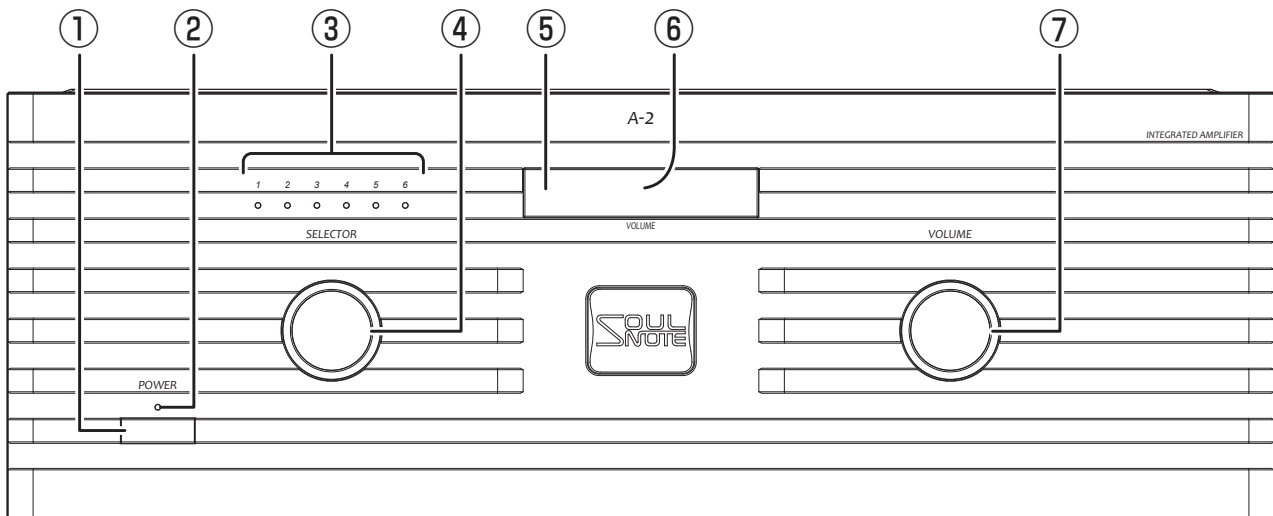

① Power Switch (Power)

Press to turn on the power, and press again to turn off. The switch returns to the same position whether the power is turned on or off.

② Power Indicator (Power)

When the power is turned on, the indicator is lit red. When in power amplifier mode, the indicator is lit blue.

③ Input Indicators

The indicator of the selected input source is lit.

④ Input Selector Jog Dial

An input source (1 to 6) can be selected by turning the jog dial.

Note:

- Even after turning off the power, the latest selection made with the jog dial will remain in the memory.

⑤ Remote Sensor

The remote sensor receives infrared signals from the remote control.

⑥ Audio Volume Display

The lowest audio volume is "0" and the largest is "35." The display flashes while muted.

⑦ Volume Jog Dial

Audio volume can be adjusted by turning the jog dial. Turn in clockwise to increase the volume. The volume can be adjusted in 36 increments from 0 to 35 increments.

Note:

- Even after turning off the power, the latest volume setting made with the jog dial will remain in the memory.

If the volume is set to 26 or higher, the volume of 25 will remain in the memory for your safety.

- An operation noise occurs during the volume setting due to relay switching inside the main unit. This is not a malfunction.

Rear Panel Names and Functions

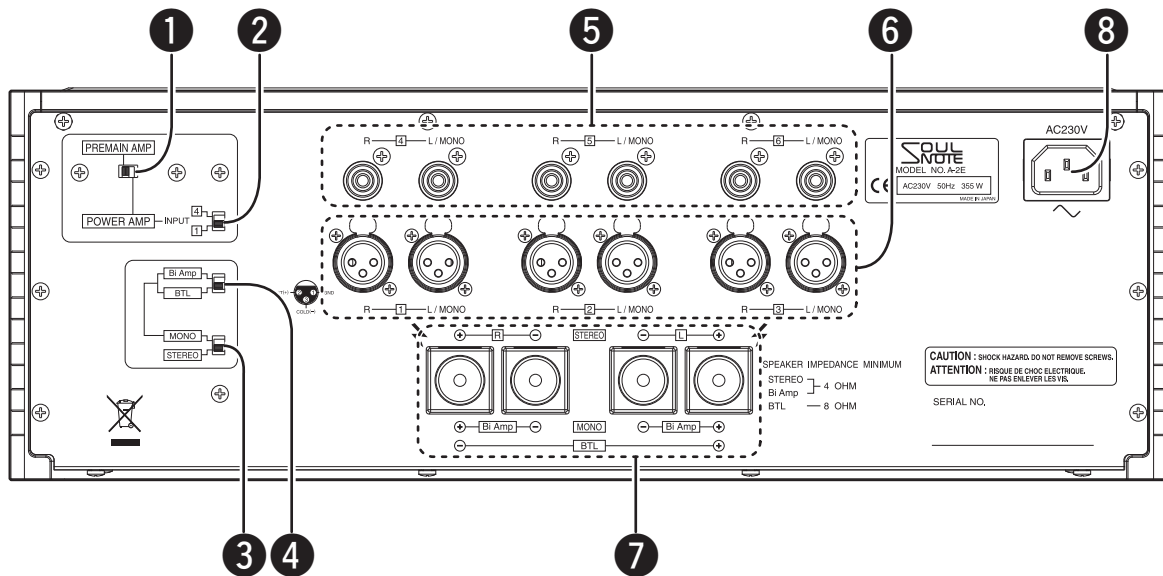

1 Pre-main Amplifier/Power Amplifier Selector Switch

With this switch, the amplifier mode can be switched between pre-main amplifier and power amplifier.

Notes:

- When in power amplifier mode, the micro-computer stops and the input selector jog dial and the volume jog dial are disabled.
- When in power amplifier mode, the inputs **2**, **3**, **5**, and **6** are disabled.

2 Input Selector Switch for Power Amplifier Mode

When in power amplifier mode, the input mode can be selected from input **1** (XLR input) and input **4** (RCA input).

3 Stereo/Mono Selector Switch

Stereo or mono mode can be selected.

4 BTL/Bi-amp Selector Switch

When in mono mode, the connection type can be selected from BTL and Bi-amp.

5 Input Terminals (RCA)

These terminals are used to input unbalanced audio signals via an RCA pin cable. When in mono mode, use the L channel for the input.

6 Input Terminals (XLR)

These terminals are used to input balanced audio signals via an XLR connector cable. When in mono mode, use the L channel for the input.

7 Speaker Terminals

These terminals are used for speaker connections. To each of these speaker terminals, 4-ohm or higher speakers can be connected. When in Bi-amp mono mode, the same sound is output from both the left and right channels. When in BTL mono mode, connect \oplus of the speaker to L channel \oplus and \ominus of the speaker to R channel \oplus .

Notes:

- Turn off the power before connecting a cable to the input terminal or the speaker terminal, or before reconnecting speakers that are connected via speaker cables.
- Due to the superior frequency characteristic of the main unit, DO NOT connect any devices other than speakers. Connecting a speaker selector or measuring equipment causes a high-frequency connection of the input GND and the output GND, which may result in protection circuit activation or malfunction of the main unit.

- Place the speaker cables and the input cables as far away from each other as possible.
- Connecting a speaker with less than 4-ohm impedance may cause sound distortion or protection circuit activation during playback.
- While each of output terminals consist of the ⊕ (red) and ⊖ (black) polarities, speaker systems also have the ⊕ and ⊖ polarities. Be sure to connect ⊕ to ⊕ and ⊖ to ⊖ (except for BTL connections).

8 AC Inlet

Connect to a 230 V AC wall outlet (mains) with the supplied power cable.

■ Mode Setting and Combinations

By combining settings using the selector switches 1, 2, 3, and 4, the following 6 types of mode are available.

- Stereo, pre-main amplifier
- Bi-amp, mono, pre-main amplifier
- BTL, mono, pre-main amplifier
- Stereo, power amplifier
- Bi-amp, mono, power amplifier
- BTL, mono, power amplifier

For connections in each mode, refer to the following table.

Selector switch position			Input						Speaker terminals			
			1	2	3	4	5	6				
PREMAIN AMP	STEREO	L-CH	✓	✓	✓	✓	✓	✓	L-CH	⊕	✓	
		R-CH	✓	✓	✓	✓	✓	✓	R-CH	⊖	✓	
	MONO	BI-AMP	L-CH	✓	✓	✓	✓	✓	✓	L-CH	⊕	✓
			R-CH							R-CH	⊖	✓
	MONO	BTL	L-CH	✓	✓	✓	✓	✓	✓	L-CH	⊕	✓
			R-CH							R-CH	⊖	-
POWER AMP	STEREO	L-CH	✓			✓			L-CH	⊕	✓	
		R-CH	✓			✓			R-CH	⊖	✓	
	MONO	BI-AMP	L-CH	✓			✓			L-CH	⊕	✓
			R-CH							R-CH	⊖	✓
	MONO	BTL	L-CH	✓			✓			L-CH	⊕	✓
			R-CH							R-CH	⊖	-

Remote Control Button Names and Functions

Grayed-out buttons are not supported by this equipment.

Note:

These buttons can be used for devices such as SOULNOTE CD players.

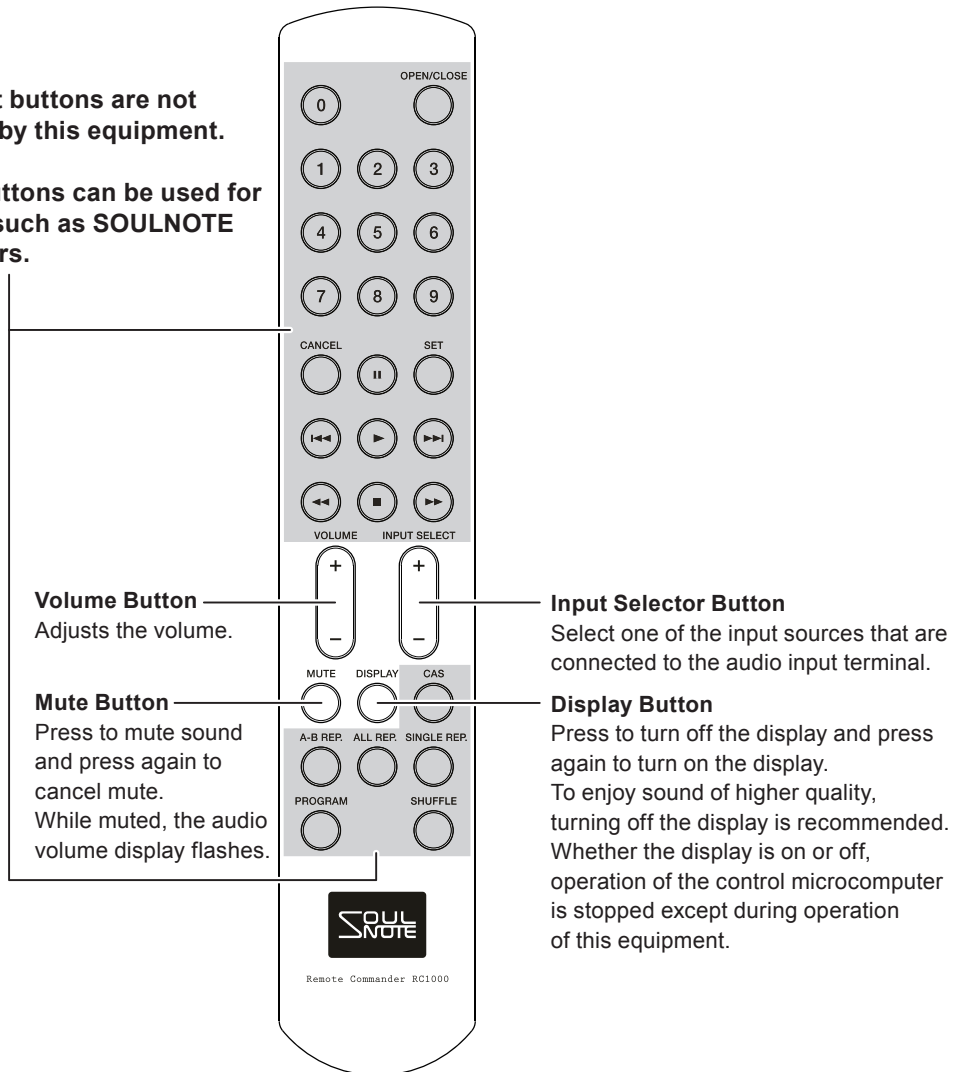

Display

■ Normal Display

The volume is displayed as a 2-digit number.

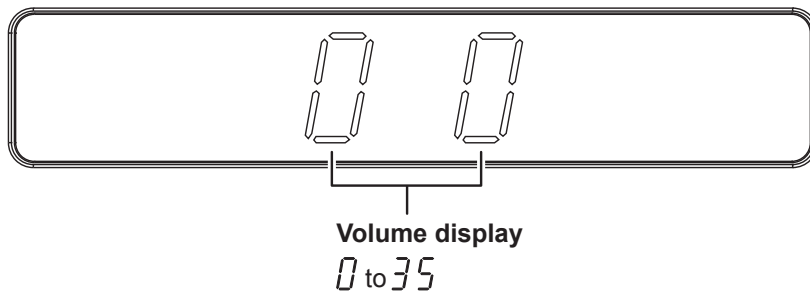

Remote Control

■ Notes on Operation

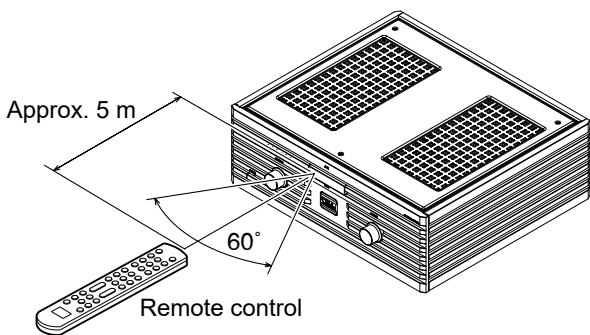

Operate the remote control within approx. 5 m distance from the front panel of the main unit within an angle of 60° to the remote sensor.

- Prevent the remote sensor from being exposed to strong light.
- Do not place any obstacles between the remote control and the remote sensor.
- Do not use other remote controls while using the remote control for the main unit.

■ How to Change the Batteries

Remove the lid on the rear side of the remote control and insert 2 AAA (LR03/R03) batteries as indicated inside the battery compartment. After inserting the batteries, attach the cover again.

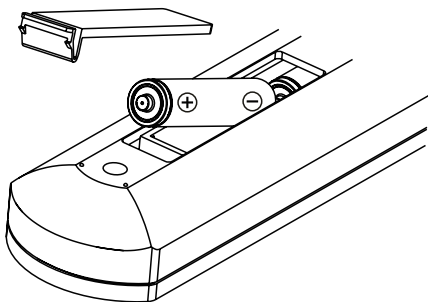

Cautions on Batteries

- Use AAA (LR03/R03) batteries for the remote control.
- Replace the remote control batteries with new ones after approx. 1 year has passed.
- If you cannot operate the main unit by using the remote control at a short distance from the main unit, change the batteries with new ones even if 1 year has not yet passed.
- The supplied batteries are only for an operation check. Replace them with new ones as soon as possible.

- Insert batteries with the correct polarity as indicated by the “+” and “-” symbols inside the battery compartment.
- Do not use old and new batteries at the same time. Doing so may cause battery leakage or rupture. Furthermore, do not use different types of batteries together.
- Do not short-circuit, disassemble, or heat batteries. Do not throw batteries into a fire.
- When not using the remote control for a long period of time, remove the batteries.
- If battery leakage occurs, wipe the battery liquid from the battery compartment and then insert new batteries.
- When disposing of batteries, follow appropriate local guidelines and regulations such as ordinances.

Balanced Input/Output

The XLR Connector is used for Balanced Input/Output. There are two types of connection, “European Type” and “USA Type”.

1. European Type (adapter for this equipment) (pin 2 = HOT, pin 3 = COLD)

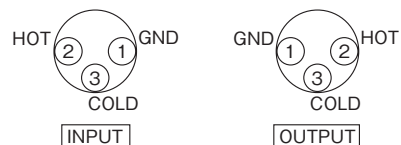

2. USA Type (pin 2 = COLD, pin 3 = HOT)

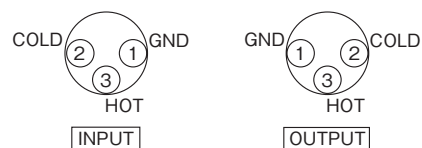

On this equipment, use the XLR type selection switch (XLR) to select the desired type.

Attaching the Spike Pins

If you replace the 3 feet attached to the main unit with the 3 supplied spike pins, you can tune the audio quality with 3-point grounding. The point grounding makes the sound focus and auditory lateralization sharper. Furthermore, the audio quality can be subtly tuned by changing the material of the surface on which the main unit is installed.

Note:

- When the spike pins are attached, it may be difficult to keep weight balance stable. Take great care not to carelessly apply a force on the corners of the main unit.

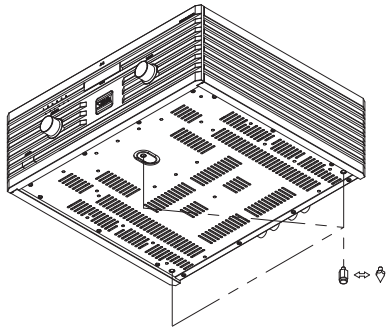

⚠ Cautions

- When using the spike pins, be extremely careful not to get injured, etc.
- When using the spike pins, be careful that the surface on which the main unit is installed such as the surface of a table, shelf, etc., may become damaged.

Troubleshooting

No sound is output.

- Check that the power of the main unit is on.
- Check that the appropriate input source is selected.
- Check the connections of the external devices.
- Check that the power of the external devices is on.
- Check that the operations and settings on the external devices are correct.
- Check the connections of the speaker system.

The remote control does not operate.

- Check that the remote control batteries are not worn out.
- Check that the distance between the remote control and the main unit is not too far or that there is no obstacle between the remote control and the main unit.

Maintenance

When the equipment has become dirty, wipe it clean using a soft cloth. To remove stubborn stains, dilute some dish-washing liquid in 5 or 6 times as much water, soak a soft cloth in the solution, wring it out well, wipe away the stains, and then wipe the surfaces dry with a dry cloth.

Never use alcohol, paint thinners, benzene, insecticides or other volatile substances since they may mar or remove the surface gloss.

Bear in mind that rubbing surfaces with a chemical cleaning cloth or leaving such a cloth in contact with a surface for an extended time may result in deterioration.

Specifications

Rated output.....	100 W x 2 (8 ohm)
	200 W x 2 (4 ohm)
	400 W x 1 (8 ohm BTL)
Total harmonic distortion	0.03% (50 W, 8 ohm)
Frequency characteristic	
Speaker (8 ohm, 1 W) ...	3 Hz to 240 kHz (±1.0 dB)
Input sensitivity/impedance	
LINE1	700 mV/16 kohm
LINE2, 3, 4	700 mV/8 kohm
S/N ratio	110 dB (IHF A network)
Power voltage.....	230 V AC , 50 Hz
Power consumption.....	355 W
	125 W (during idling)
Maximum external dimensions	
	430 (W) x 160 (H) x 423 (D) mm
Weight	20 kg



CSR, Inc.

<https://www.soulnote.link/>